

Dossier de Madame Massange

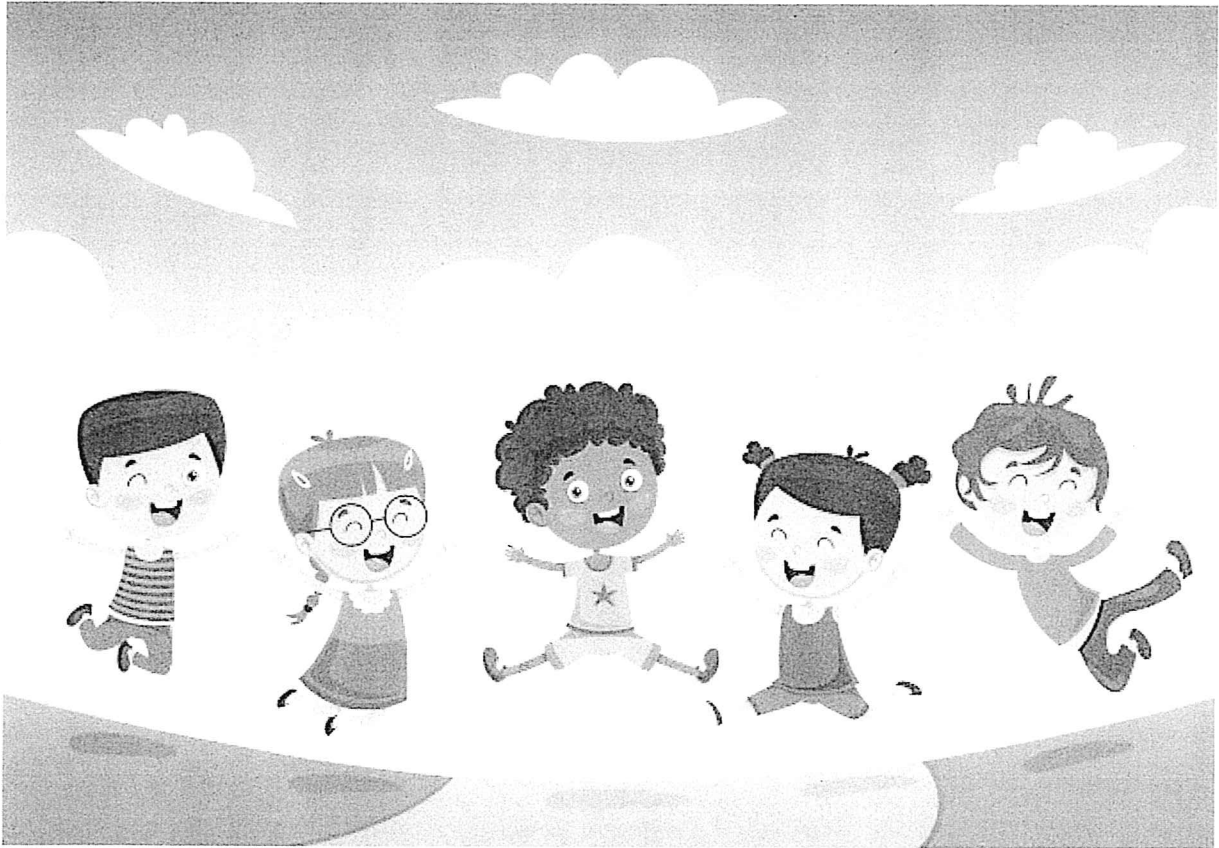

Bon travail !

Coloriage magique

Colorie



en respectant le code couleur.

| | | |
|-------|---|---|
| D | d | d |
| jaune | | |

| | | |
|------|---|---|
| B | b | b |
| vert | | |

| | | |
|--------|---|---|
| G | g | g |
| orange | | |

| | | |
|-------|---|---|
| P | p | p |
| rouge | | |

| | | |
|------|---|---|
| Q | q | q |
| bleu | | |

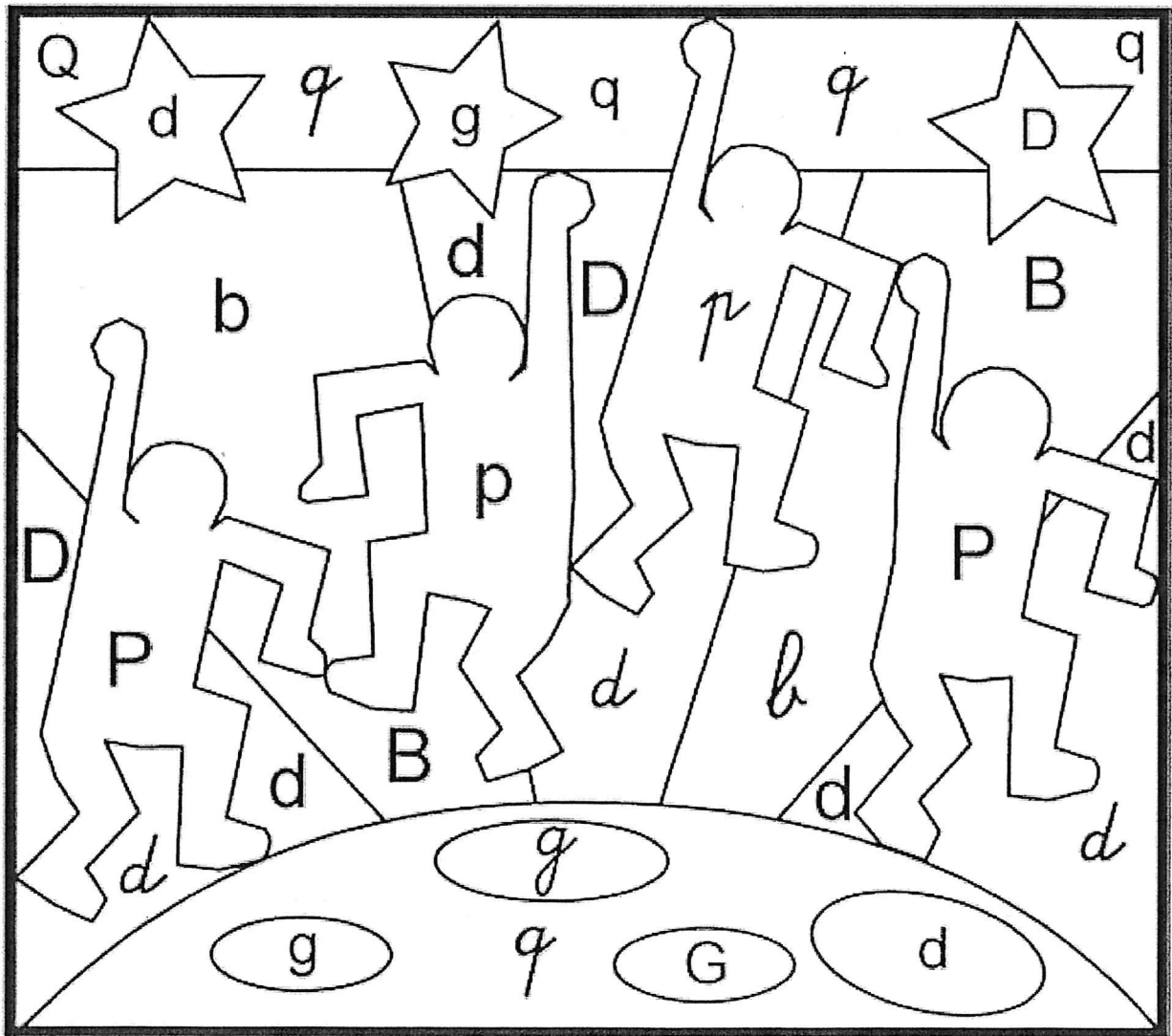

Points à relier de A à Z

Relie

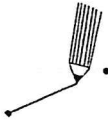

les lettres de A à Z.

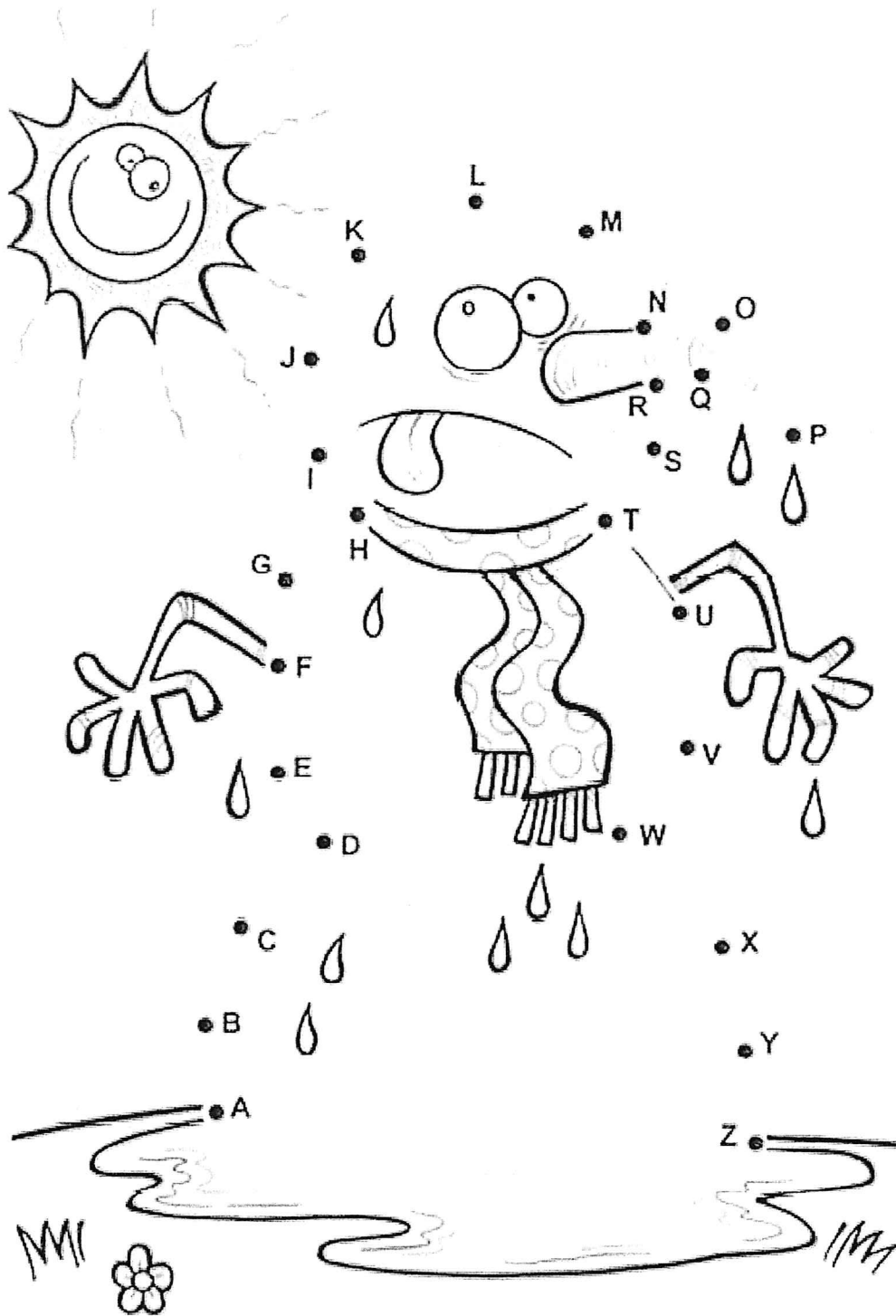



Mots croisés : le son « a »

CHOCOLAT - MOTOT- TOMATE - VOLET - VELO - LOCOMOTIVE - COCHON - ROBOT

The crossword puzzle grid is composed of empty cells. The words and their starting points are as follows:

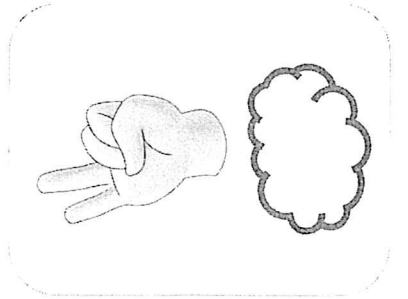
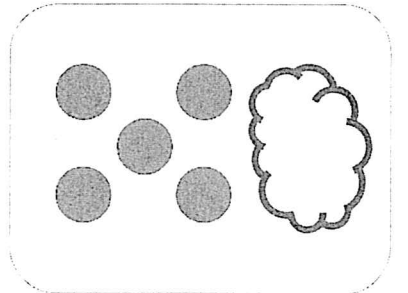
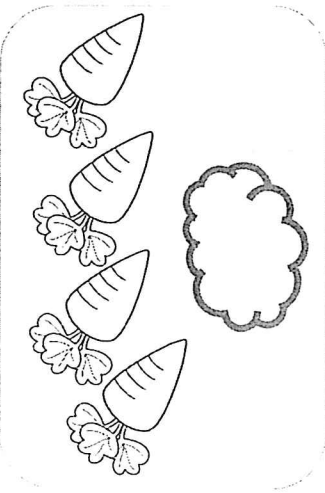
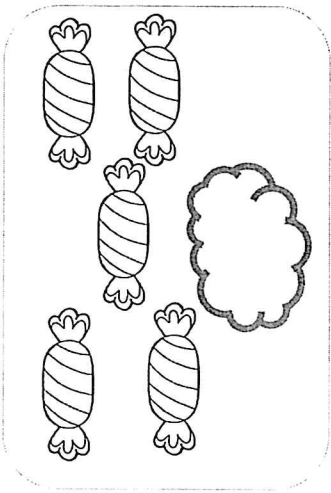
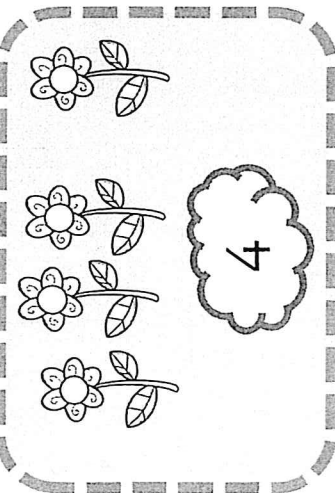
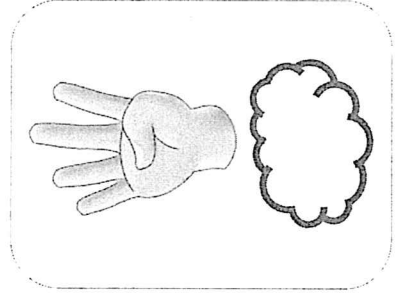
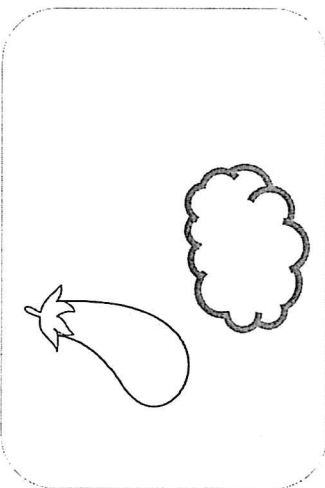
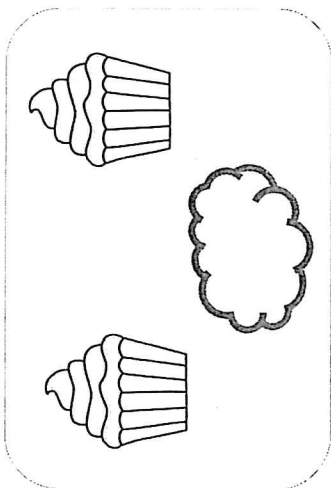
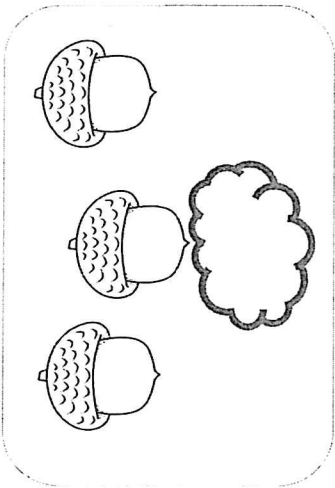
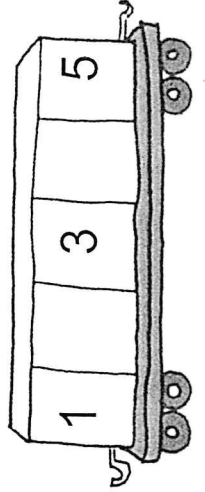
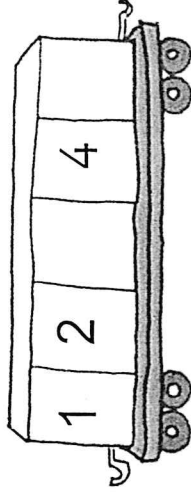
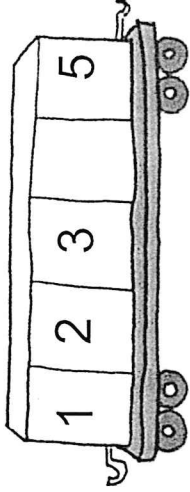
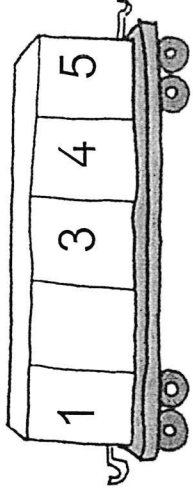
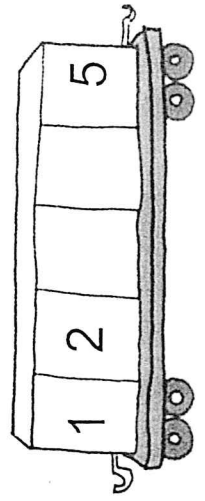
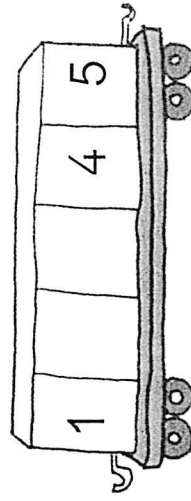
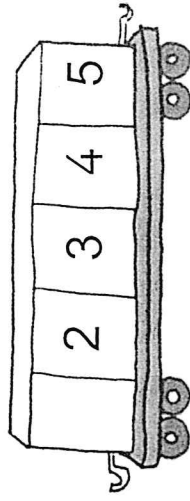
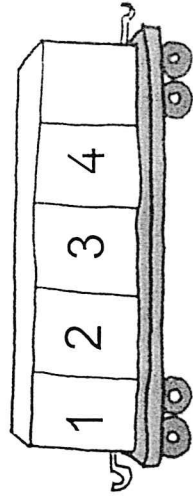
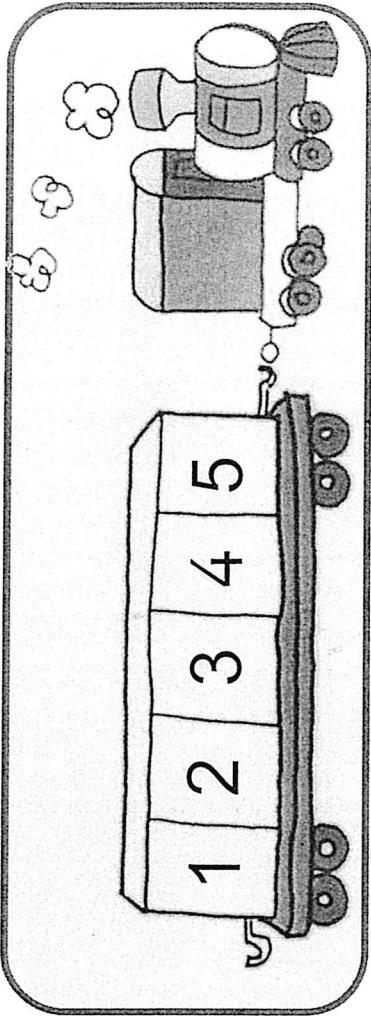
- CHOCOLAT**: A vertical word starting at the 2nd row, 1st column, indicated by a chocolate bar illustration and a downward arrow.
- MOTOT**: A horizontal word starting at the 3rd row, 2nd column, indicated by a motorcycle illustration and a rightward arrow.
- TOMATE**: A horizontal word starting at the 5th row, 2nd column, indicated by a tomato illustration and a rightward arrow.
- VOLET**: A horizontal word starting at the 8th row, 2nd column, indicated by a window shutter illustration and a rightward arrow.
- VELO**: A horizontal word starting at the 3rd row, 1st column, indicated by a bicycle illustration and a rightward arrow.
- LOCOMOTIVE**: A vertical word starting at the 2nd row, 4th column, indicated by a steam locomotive illustration and a downward arrow.
- COCHON**: A vertical word starting at the 4th row, 2nd column, indicated by a pig illustration and a downward arrow.
- ROBOT**: A vertical word starting at the 1st row, 7th column, indicated by a robot illustration and a downward arrow.



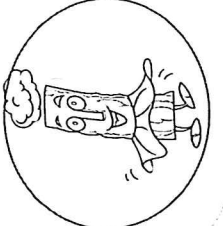

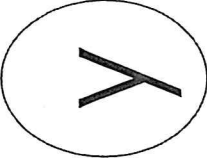

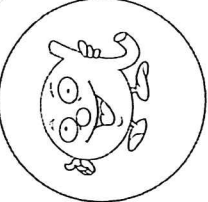
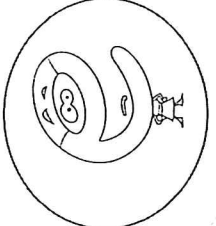

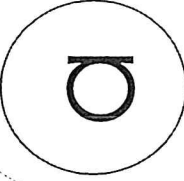
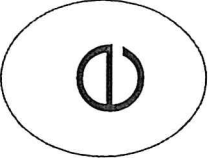

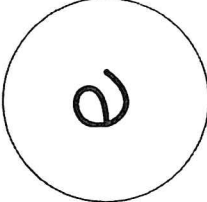
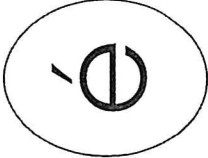



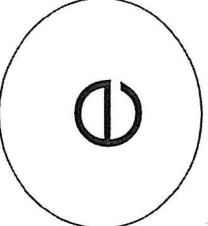



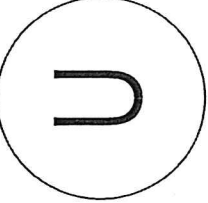
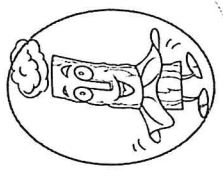



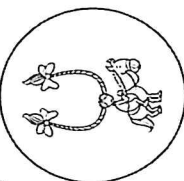
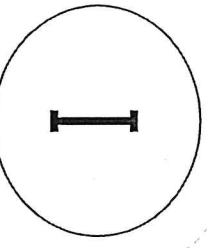



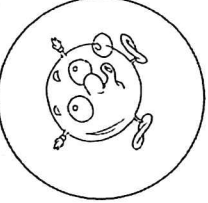
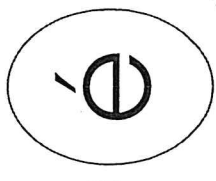



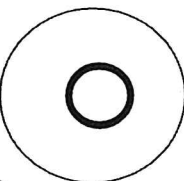



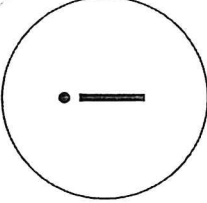
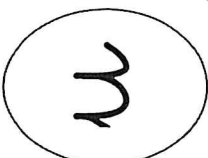



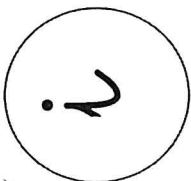
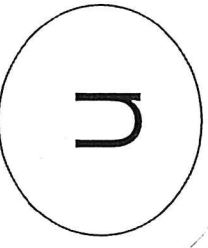



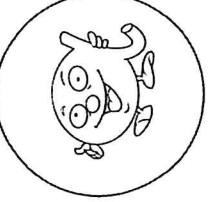
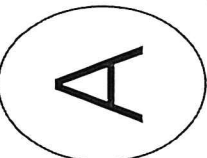



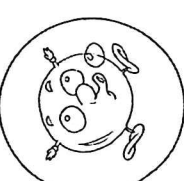
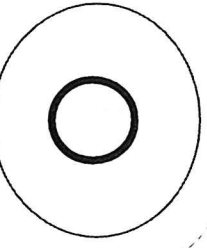



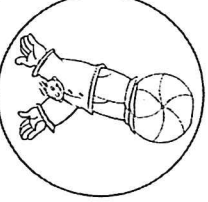
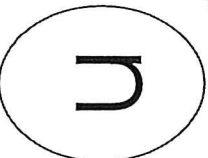



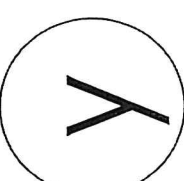
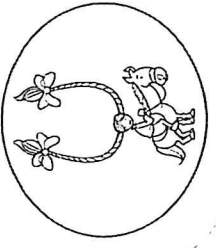



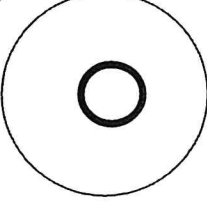
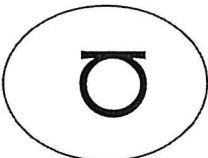



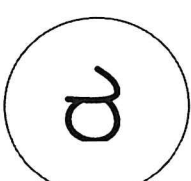
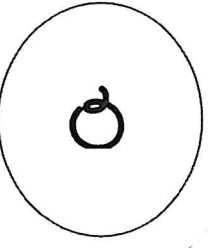



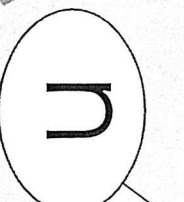
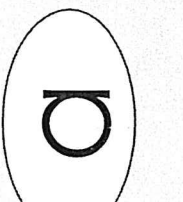



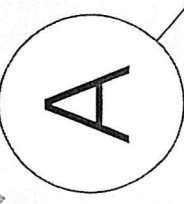
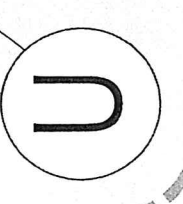



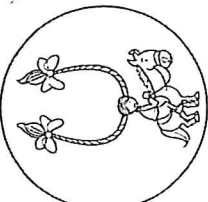
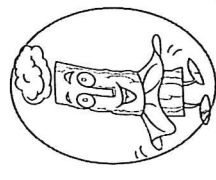



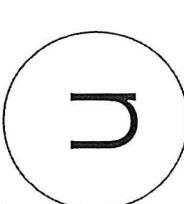
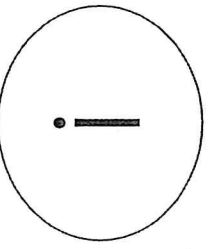



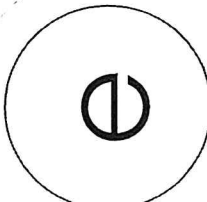
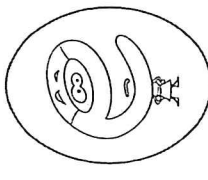



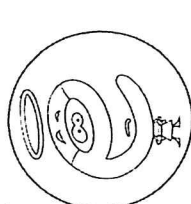
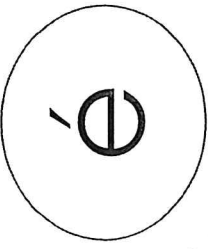

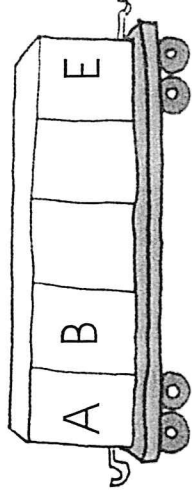
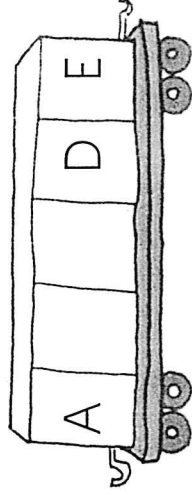
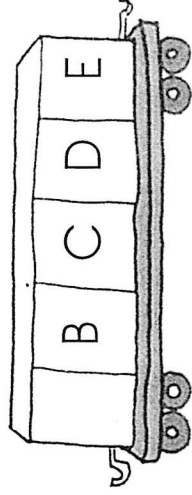
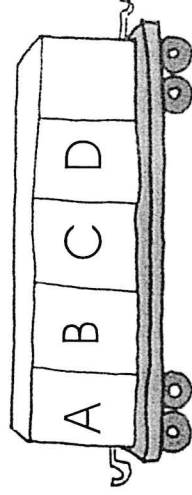
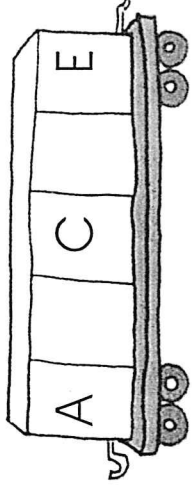
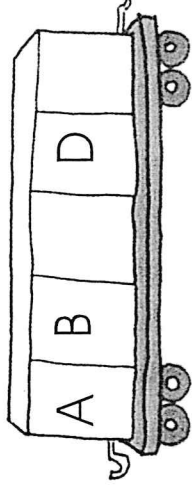
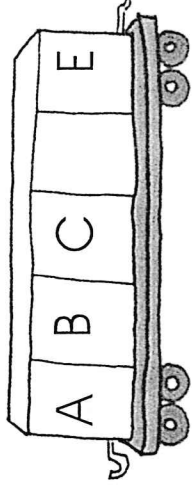
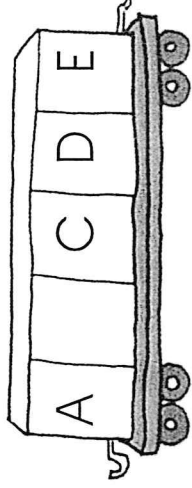
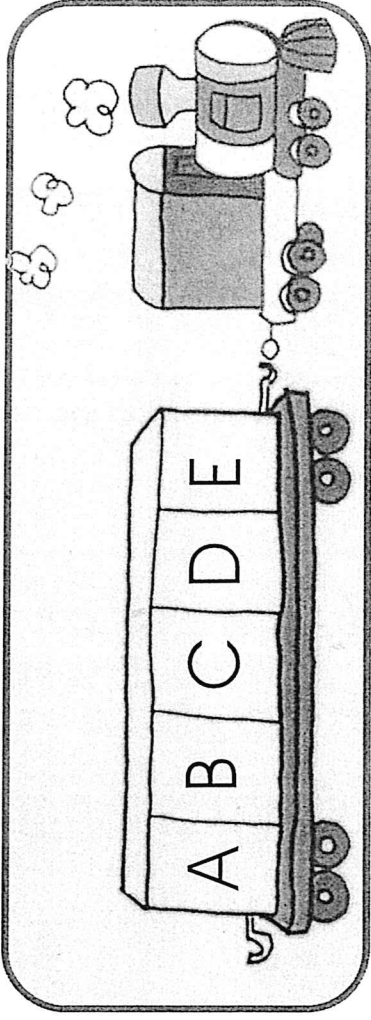
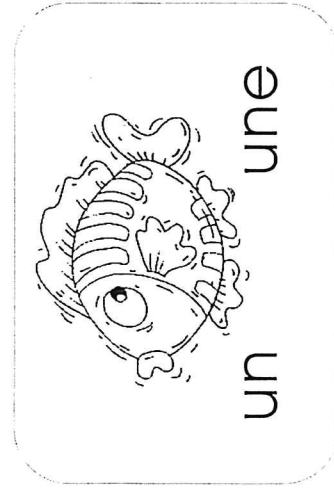
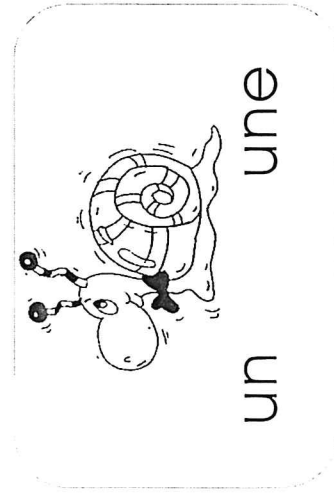
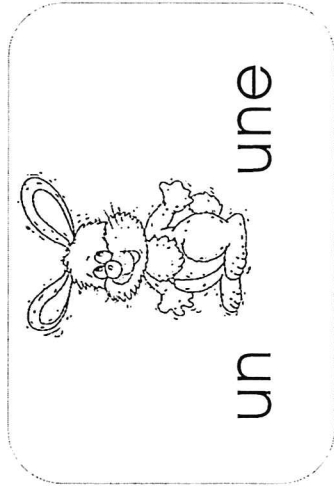
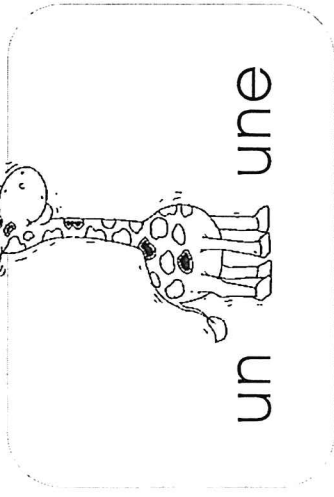
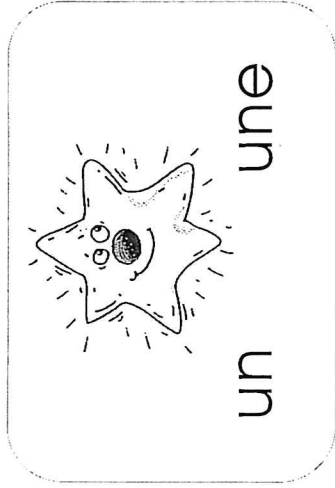
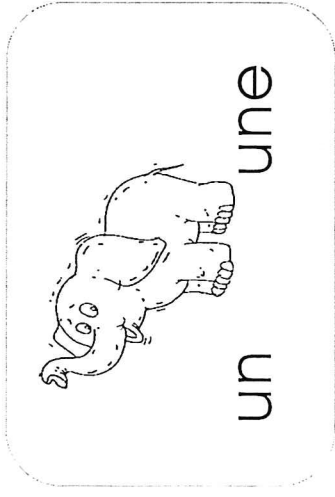
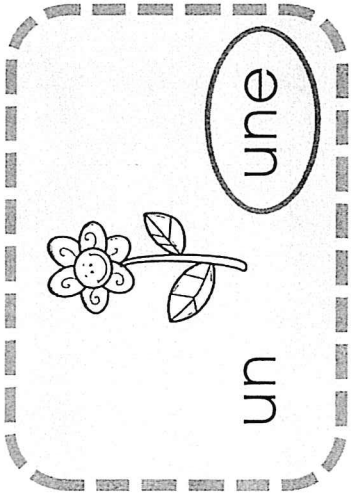

mie - fée - fa
mie - fée - fa

ami - fumée - mamie
ami - fumée - mamie

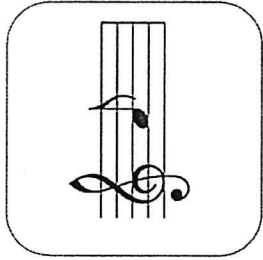
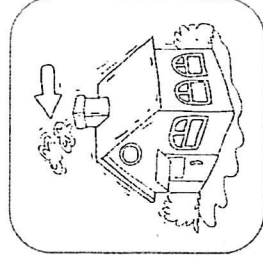
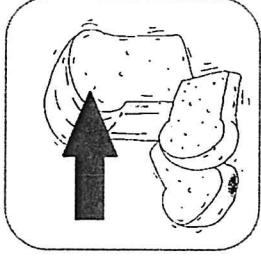
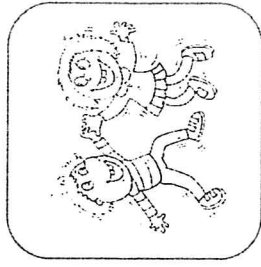

Handwriting practice lines consisting of three horizontal lines for each row.

Circle 1: Circle 2: **f** Circle 3: Circle 4: **m**

Circle 1: **F** Circle 2: **m** Circle 3: **f** Circle 4: **M**

Circle 1: **M** Circle 2: **M** Circle 3: **F** Circle 4: **F**

Circle 1: **F** Circle 2: **M** Circle 3: **f** Circle 4: **m**

Circle 1: **f** Circle 2: **m** Circle 3: **f** Circle 4: **m**

Circle 1: Circle 2: **f** Circle 3: Circle 4: **m**

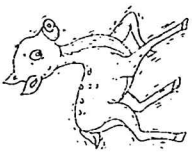
| | |
|--|-------|
|  | bûche |
| | bâche |
| | biche |

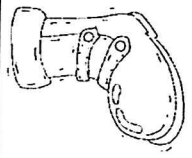
| | |
|--|-------|
|  | botte |
| | bête |
| | pot |

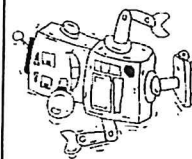
| | |
|--|-------|
|  | robe |
| | robot |
| | rébus |

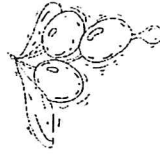
| | | | |
|--|----|----|----|
|  | o | u | ve |
| | li | mi | ze |
| <i>olive</i> | | | |

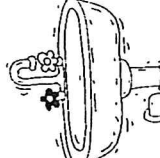
| | | | |
|--|----|----|----|
|  | ja | va | bo |
| | la | da | ba |

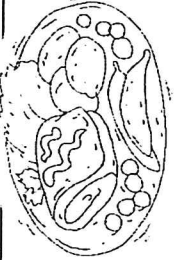
| | |
|---|-------|
|  | répit |
| | repu |
| | repas |

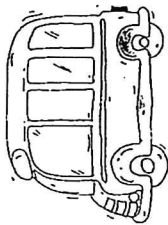
| | |
|---|-------|
|  | bûche |
| | bus |
| | butte |

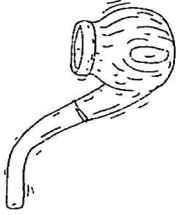
| | |
|---|------|
|  | pile |
| | pipe |
| | pie |

| | | | |
|--|----|----|----|
|  | pe | do | te |
| | te | lo | fe |

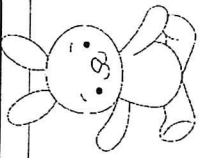
| | | | |
|---|----|----|-----|
|  | pe | du | se |
| | te | lu | che |

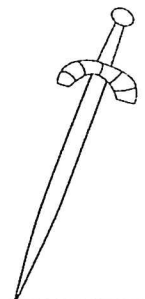
| | |
|---|---------|
|  | épi |
| | épée |
| | épluche |

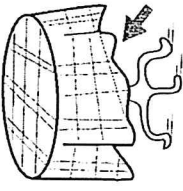
| | |
|---|-------|
|  | nasse |
| | natte |
| | nappe |

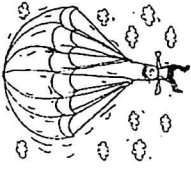
| | |
|---|-----------|
|  | parachute |
| | parasol |
| | parapluie |

| | | | |
|--|----|----|----|
|  | ti | ra | te |
| | pi | da | de |

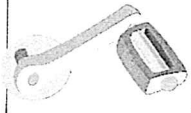
| | | | |
|---|----|----|----|
|  | pé | fa | me |
| | té | da | le |

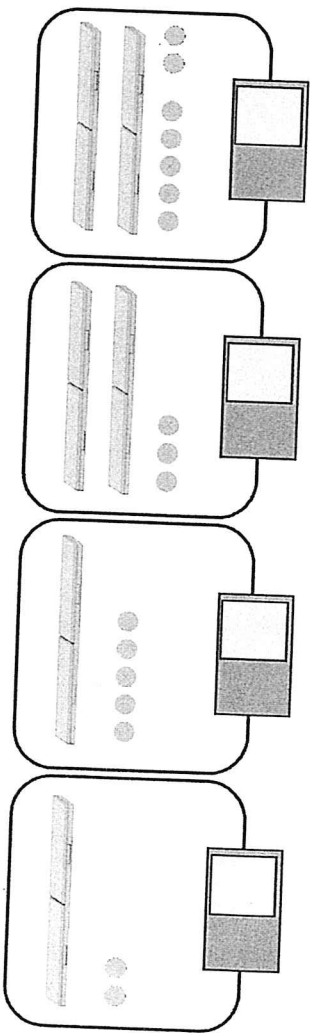
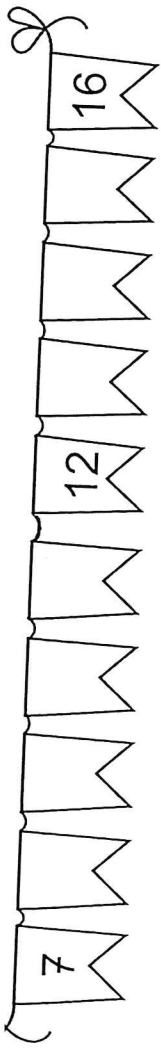

| | | | | | |
|----|----|----|----|----|----|
| 10 | 15 | 12 | 18 | 16 | 19 |
| 17 | 7 | 15 | 19 | 12 | 19 |
| | | 15 | 5 | 13 | 18 |

$10 + 7 = \dots\dots\dots$
 $10 + 1 = \dots\dots\dots$
 $10 + 8 = \dots\dots\dots$
 $10 + 5 = \dots\dots\dots$
 $10 + 4 = \dots\dots\dots$
 $10 + 9 = \dots\dots\dots$

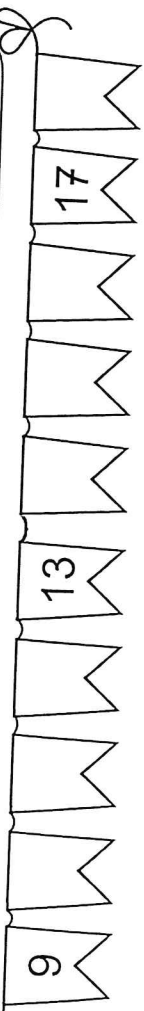

| | | | | |
|--------------------------|--------------------------|--------------------------|--------------------------|--------------------------|
| 4 | 5 | 3 | 4 | 5 |
| 4 + <input type="text"/> | 3 + <input type="text"/> | 2 + <input type="text"/> | 2 + <input type="text"/> | 4 + <input type="text"/> |
| 3 | 4 | 5 | 3 | 5 |
| 0 + <input type="text"/> | 3 + <input type="text"/> | 2 + <input type="text"/> | 1 + <input type="text"/> | 1 + <input type="text"/> |

$7 + 3 = 10$

$8 + 2 = 10$

$9 + 1 = 10$